

NOTES:

1. HOLES AND INTERFACE DIMENSIONS PER MIL-PRF-83513/2.
2. MATEABLE WITH CONNECTORS MANUFACTURED PER MIL-PRF-83513/1 AND MIL-PRF-83513/3.
3. DESIGNED TO BE O-RING SEALED AND FASTENED WITH HARDWARE.
4. HERMETIC LEAK RATE: LESS THAN OR EQUAL TO 1×10^{-9} CC/SEC He AT 1 ATM DIFFERENTIAL PRESSURE.
5. ELECTRICAL REQUIREMENTS:
 - INSULATION RESISTANCE: GREATER THAN 5,000 MEGOHMS AT $500 \pm 10\%$ VDC AT 25°C WHEN TESTED IAW MIL-STD-1344, METHOD 3003.
 - DIELECTRIC WITHSTANDING VOLTAGE: MUST SHOW NO EVIDENCE OF BREAKDOWN OR FLASHOVER WHEN SUBJECTED TO 600 VAC RMS 60Hz IAW MIL-STD-1344, METHOD 3001. DURATION OF APPLICATION TO BE 1 SEC MIN.

6. MATERIALS:
 - SHELL: 304L STAINLESS STEEL.
 - CONTACTS: BERYLLIUM-COPPER IAW ASTM B196 OR ASTM B197.
 - INSULATORS: KRYOFLEX 313 PROPRIETARY POLYCRYSTALLINE CERAMIC.
 - INTERFACIAL SEAL: FLUOROSILICONE RUBBER IAW MIL-R-25988, CLASS I, TYPE II, GRADE 60.
 - MALE-FEMALE HEX STANDOFFS: 300-SERIES STAINLESS STEEL.
 - SOLDERCUP PIN ADAPTER: BERYLLIUM-COPPER IAW ASTM B196 OR ASTM B197.

7. FINISHES:
 - CONTACTS: ELECTROLYTIC NICKEL PLATE IAW QQ-N-290, .000100/.000250 THICK.
 - GOLD PLATE IAW ASTM B488, TYPE II, GRADE C OR MIL-G-45204, TYPE II, GRADE C, .000050/.000150 THICK.

8. ORDERING INFORMATION:
 - PLEASE SPECIFY ACCORDING TO THE FOLLOWING
 - 93413-1
 - PART NUMBER TO ORDER

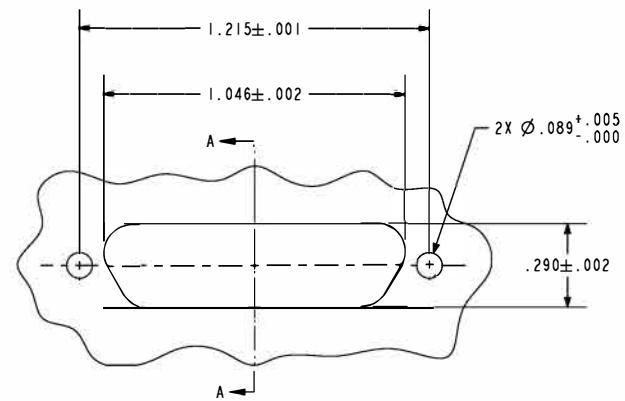
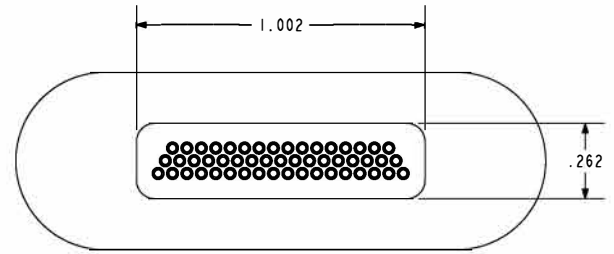
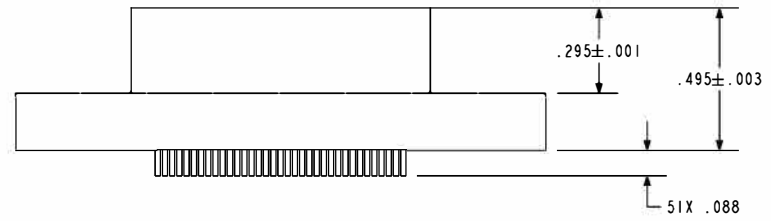
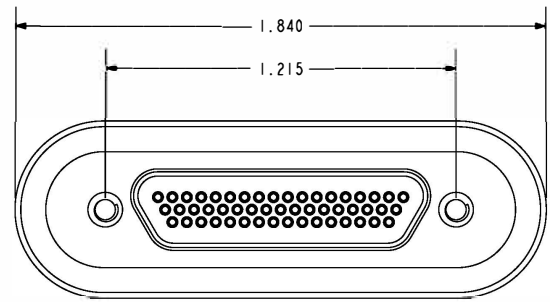

HOLE DETAIL
SCALE 1.500

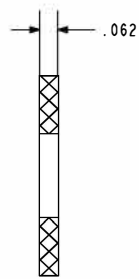

SECTION A-A

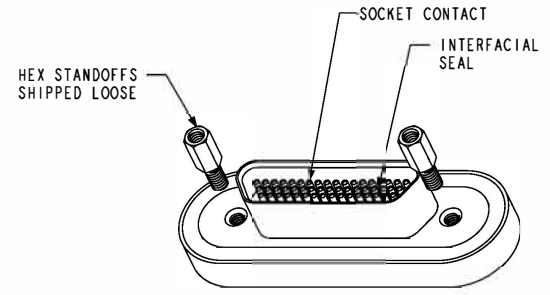
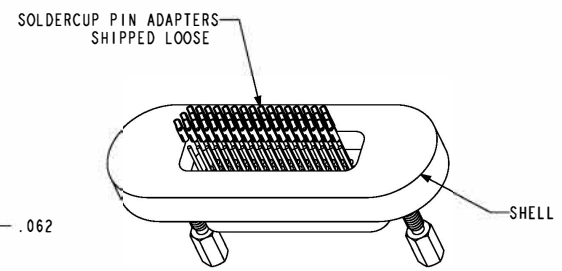

PACAE
A Division of
HERMETIC SOLUTIONS
The Heliumic Revolution
434 Olds Station Rd. Wenatchee WA 98801

WWW.PACAERO.COM

TITLE: CONNECTOR, MICRO-D, O-RING MOUNT, 51 PIN

THIRD ANGLE PROJECTION
CAGE CODE: 64567

VERSION: L.0
RELEASE DATE: 08-09-11

SALES DRAWING

SHEET: 1 OF 1

DOCUMENT: 0-93413